



A TESCO COMPANY

OPERATIONS MANUAL

VOLTAGE TRANSFORMER TESTING SYSTEM

PRODUCT:

CATALOG NO. KVTS

**VOLTAGE TRANSFORMER TESTING
SYSTEM
OPERATIONS MANUAL
CATALOG NO. KVTS**



THE EASTERN SPECIALTY COMPANY

© 2021 TESCO - The Eastern Specialty Company

All Rights Reserved.

Specifications are subject to change without prior notice.

Revision: 1.0.1

TESCO – The Eastern Specialty Company

925 Canal Street Bristol, PA, 19007

Phone: 215.228.0500

support@tescometering.com

www.tescometering.com

LIMITED WARRANTY & LIMITATION OF LIABILITY

TESCO warrants to the original purchaser that it will correct all defects in material and/or workmanship in the Instrument, test equipment or software covered by this warranty (herein called "**PRODUCT**"), provided that TESCO is notified of such defect within the warranty period (set forth below) in accordance with paragraph four of this Warranty.

WARRANTY PERIOD. The warranty period shall begin on the date of shipment of the PRODUCT or the date of the issuance of this warranty certificate, whichever is later. If no warranty period is specified below and signed by an authorized DISTRIBUTOR of TESCO, the Warranty Period shall be one (1) year. In no event shall this Warranty remain in effect for more than the stated Warranty Period plus two (2) months after the date of shipment. TESCO's sole obligation and the purchaser's sole remedy under this Warranty is limited to repair or replacement, at TESCO's option, free of charge, F.O.B. TESCO's factory at Bristol, PA of any workmanship and/or part which in TESCO's sole judgment displays evidence of defect. On-site Warranty repairs will be made when in TESCO's judgment the PRODUCT cannot practically be shipped to TESCO's factory. Any modifications, additions or upgrades made to the PRODUCT or control software after this warranty becomes effective shall not extend the term of this warranty.

COVERAGE. The warranty set forth above shall be applicable only if the PRODUCT:

1. Is used for the specific purpose for which it was intended;
2. Is operated in accordance with instructions, if any, supplied by TESCO;
3. Has not been modified, neglected, altered, tampered with, vandalized, abused or misused, or subjected to accident, fire, flood or other casualties;
4. Has not been repaired by unauthorized persons;
5. Has not had its serial number altered, defaced or removed;
6. Has not been connected, installed or adjusted other than in accordance with the instructions, if any, furnished by TESCO.

The warranty set forth herein DOES NOT APPLY to defects resulting from ordinary wear, tear and usage, or any cause, similar or dissimilar, not resulting solely from defective material and/or workmanship.

The Warranty set forth herein shall NOT be effective unless:

1. Notice of defect is given to TESCO by phone, fax, email, or mail as soon as the defect is discovered.
2. Notice of defect contains the following information: PRODUCT serial number, PRODUCT model number, date of original installation, and an accurate and complete description of the defect including the exact circumstances leading to the defect.
3. The defective PRODUCT or part is returned only upon authorization from TESCO as evidenced by the issuing of a Return Merchandise Authorization (RMA) number, and that the transportation charges are prepaid (except that TESCO may, at its option, appoint a qualified DISTRIBUTOR to make field inspections of the PRODUCT for which purpose the purchaser shall permit such DISTRIBUTOR to enter upon its premises and examine the PRODUCT).
4. The Return Merchandise Authorization (RMA) number is written on the shipping label and all paperwork defective PRODUCT or part.
5. The defective PRODUCT or part is returned in the original packing or packing approved by TESCO

TESCO is not responsible for drayage charges, damages or labor costs incurred in conjunction with failure, removal, or reinstallation of any PRODUCT, all of which shall be at the purchaser's expense. TESCO is not responsible for special, incidental, or consequential damages, whether resulting from breach of warranty, negligence, or any other reason.

TESCO manufactured parts will be available for a minimum period of at least two years after the manufacture of a PRODUCT has been discontinued.

TESCO will provide original purchaser during the Warranty Period, unlimited telephone consulting time for the purpose of PRODUCT trouble shooting/servicing and for the first thirty (30) days of the Warranty Period, unlimited telephone consulting time for the purpose of PRODUCT/software application.

THE WARRANTY CONTAINED HEREIN IS IN LIEU OF ALL OTHER WARRANTIES AND TESCO MAKES NO OTHER WARRANTIES, EXPRESS OR IMPLIED, INCLUDING, BUT NOT LIMITED TO, WARRANTIES OR CONDITION, DESIGN, MERCHANTABILITY, FITNESS FOR A PARTICULAR PURPOSE, OR ANY OTHER MATTER.

No other Warranty, express or implied, is authorized by TESCO, and no DISTRIBUTOR of TESCO or any other person has any authority to amend, extend, modify, enlarge, or otherwise alter the foregoing warranty and disclaimers in any way whatsoever, except as provided for in an Extended Limited PRODUCT Warranty Agreement.

Release No.	Date	Author	Revision Description
Rev. 0	-	-	Operations Manual Template
Rev. 1.0.0	4/12/21	L.G.A	Initial Creation
Rev. 1.0.1	7/09/21	J.S.T	Updated footer and year in front page

TABLE OF CONTENTS

1.0 INTRODUCTION	1
1.1 Introduction	2
1.2 Contacting TESCO.....	2
1.3 General Safety Summary.....	2
1.4 Description of Safety-related Icons.....	3
1.5 Product Features (KVTS).....	3
1.5.1 Key Features	3
1.5.2 Standard Features.....	3
1.6 General Specifications (KVTS).....	4
1.6.1 Input Power	4
1.6.2 Dimensions	4
1.6.3 Accuracy.....	4
1.6.4 Test Ranges	4
1.6.5 Test Burdens	5
1.7 Product Features (KATC-V2)	5
1.7.1 Key Features	5
1.7.2 Standard Features.....	5
1.8 General Specifications (KATC-V2)	5
1.8.1 Input Power	5
1.8.2 Dimensions	6
1.8.3 Measurements Resolution	6
1.8.4 Measurement Accuracy	6
1.9 About this Operations Manual	6
2.0 SETUP & INSTALLATION	7
2.1 Introduction	8
2.2 AC Power.....	8
2.3 Interlock	8
2.4 Cables for Transformer Connections.....	9
2.5 Circuit Breaker (KVTS)	9
2.6 Circuit Breaker (KATC-V2).....	9

3.0 FUNCTIONALITY 10

3.1 Introduction 11

3.2 Front Panel 11

 3.2.1 KVTS..... 11

 3.2.2 KATC-V2 12

3.3 Operating Procedure..... 13

 3.3.1 Setting Network Connection 14

 3.3.2 Testing Procedure 15

4.0 MAINTENANCE 17

4.1 Introduction 18

4.2 Knopp One-to-One Test 18

4.3 Repair / Parts Replacement / Recalibration 19

1.0 INTRODUCTION

1.0 INTRODUCTION	1
1.1 Introduction	2
1.2 Contacting TESCO	2
1.3 General Safety Summary	2
1.4 Description of Safety-related Icons	3
1.5 Product Features (KVTS)	3
1.5.1 Key Features	3
1.5.2 Standard Features	3
1.6 General Specifications (KVTS)	4
1.6.1 Input Power	4
1.6.2 Dimensions	4
1.6.3 Accuracy	4
1.6.4 Test Ranges	4
1.6.5 Test Burdens	5
1.7 Product Features (KATC-V2)	5
1.7.1 Key Features	5
1.7.2 Standard Features	5
1.8 General Specifications (KATC-V2)	5
1.8.1 Input Power	5
1.8.2 Dimensions	6
1.8.3 Measurements Resolution	6
1.8.4 Measurement Accuracy	6
1.9 About this Operations Manual	6

1.2 Introduction

The Knopp Voltage Transformer Testing System is designed to measure the accuracy of instrument transformers having 120-volt secondaries and up to 14,400-volt primaries (special order for up to 36,000-volt primaries is available). The system includes a control console which contains the control circuitry, ANSI standard burdens, and the Knopp Automatic Transformer Comparator. The Knopp precision and loading transformer set is also included and is connected to the console via a special cable.

1.3 Contacting TESCO

For Technical Support or Calibration/Repair, please call 215.228.0500.

You can also send an email to support@tescometering.com with any questions.

To view, print, or download the latest manual supplement, visit www.tescometering.com.

1.4 General Safety Summary

This manual contains information and warnings that must be observed to ensure safe operation and keep the KVTS in a safe condition. Operation or service in conditions or in a manner other than specified could compromise safety. For the correct and safe use of this device, **it is essential that both operating and service personnel follow accepted safety procedures in addition to the safety precautions specified**, including PPE guidelines.



In this manual, a **WARNING** identifies conditions and actions that pose hazard(s) to the user, while a **CAUTION** identifies conditions and actions that may damage the KVTS or the test equipment.

WARNING

To avoid electrical shock, personal injury, or fire hazard:

- **The device must not be switched ON if it is damaged or suspected to be faulty.**
- **Do not operate the device in wet, condensing, dusty, or explosive gas conditions.**
- **If the equipment is used in a manner not specified in this manual, the protection provided by the KVTS may be impaired.**
- **Whenever it is likely that safety protection has been impaired, the device must be made inoperative and be secured against any unintended operation. Inform qualified maintenance or repair personnel.**
- **Safety protection is likely to be impaired if, for example, the KVTS displays visible damage or fails to operate normally.**

1.5 Description of Safety-related Icons

ICONS	DESCRIPTION
	Risk of danger. Important information. See manual.
	Hazardous voltage. Risk of electrical shock.

1.6 Product Features (KVTS)

1.6.1 Key Features

- Automatic and Autoranging Voltage Transformer Comparator (KATC-V2) provides minimal measurement time (typically a few seconds after adjustment of test voltage).
- Accuracy Class for which the transformer-under-test (TUT) qualifies is calculated and digitally displayed in real time by the comparator (KATC-V2).
- Direct simultaneous measurement of reference transformer, transformer under test and error signals.
- All parameters are monitored in real time to provide immediate error feedback. Errors such as wrong ratio, wrong polarity or open connections are sensed as soon as any voltage is applied to the transformers.

1.6.2 Standard Features

- **PROTECTIVE CIRCUITRY**
Senses error conditions, such as wrong ratio or wrong polarity, and then removes power from the KVTS loading circuitry to protect the KVTS, precision transformer, and transformer-under-test.
- **SELF CHECK**
Allows the system accuracy to be easily verified without the use of an external reference standard.
- **DIGITAL DISPLAY**
Shows test current, ratio error (in percent or Ratio Correction Factor), phase angle error (in Minutes or Miliradians), and Accuracy class of the TUT.
- **ZERO START**
Requires that both coarse and fine test current controls be at zero before power can be applied to the loading circuitry (and thus the TUT).

1.7 General Specifications (KVTS)

1.7.1 Input Power

PARAMETERS	DATA
Power Supply	120 VAC, 10 A
Supply Frequency	60 Hz

1.7.2 Dimensions

Console:

PARAMETERS	DATA
Height	61.5" (156.5 cm)
Width	24" (61 cm)
Depth	37" (94 cm)
Weight	350 lbs (159.7 kg)

Voltage Test Set:

PARAMETERS	DATA
Height	36" (91.5 cm)
Width	25" (63.5 cm)
Depth	20" (50.8 cm)
Weight	300 lbs (136.078 kg)

1.7.3 Accuracy

PARAMETERS	DATA
Measurement Accuracy	±0.025%
Phase Angle	±2 min. at 120 V

1.7.4 Test Ranges

The primary ranges depend on the transformer test set used:

- **Type 2J4:** 120 / 240 / 480 / 600 / 2,400 / 4,200 / 7,200 / 8,400 / 12,000 / 14,400 volts
- **Type 2J4-4:** 120 / 240 / 288 / 300 / 480 / 600 / 2,400 / 4,200 / 4,800 / 7,200 / 8,400 / 12,000 / 14,400 volts
- **Type 2J6-1:** 14,400 / 18,000 / 20,760 / 36,000 volts
- **Type 2J6-2:** 14,400 / 16,800 / 24,000 / 36,000 volts
- **Type 2J6-3:** 14,400 / 21,000 / 24,000 / 36,000 volts
- **Type 2J6-5:** 14,400 / 24,000 / 36,000 / 48,000 volts
- **Type 2J6-6:** 14,400 / 21,000 / 24,000 / 36,000 / 48,000 volts

1.7.5 Test Burdens

These ANSI burdens are switch selectable: W, X, M, Y, Z, and ZZ. Provisions are made for use of an external burden.

1.8 Product Features (KATC-V2)

1.8.1 Key Features

- 178ppi Full Color LCD Screen
- Front Keypad for Data Entry
- Front USB and Ethernet Connectivity
- Powerful, multi-core, 32-bit processors
- 0.001 Accuracy Class Resolution, 0% to 400% of Accuracy Class Measurable
- Reduced Testing Time

1.8.2 Standard Features

- Auto-Rundown Capable
- Automatic Sensing of 50 or 60 Hertz
- Configurable Units
(Degrees, MilliRads, Minutes), (Amps, %Ratio), (RCF, %Error)
- 120V Secondary Voltage Measurement
- 3U Compatible Enclosure

1.9 General Specifications (KATC-V2)

1.9.1 Input Power

PARAMETERS	DATA
Power Supply	85 to 250 VAC, 2.5 A
Supply Frequency	50/60Hz

1.9.2 Dimensions

PARAMETERS	DATA
Height	5.25" (13.33 cm)
Width	19" (48.26 cm)
Depth	18.1" (45.97 cm)
Weight	≈25 lbs (≈11.33 kg)

NOTE: This is a standard 3U rack enclosure.

1.9.3 Measurements Resolution

Valid for 50Hz/60Hz and Voltage of 30VAC to 150VAC.

PARAMETERS	RCF	Phase Angle	Acc. Class
0.0% ≤ Acc. Cl. < 0.2%	0.000 000 1	0.001'	0.000 1
0.2% ≤ Acc. Cl. < 0.7%	0.000 000 1	0.001'	0.000 1
0.7% ≤ Acc. Cl. < 1.4%	0.000 000 1	0.001'	0.000 1
1.4% ≤ Acc. Cl. < 10.0%	0.000 000 1	0.001'	0.000 1
10.0% ≤ Acc. Cl.	0.000 000 1	0.001'	0.000 1

1.9.4 Measurement Accuracy

Valid for all current comparators, provided Calibration Certification will provide further detail.

Valid for 50Hz/60Hz and Current of 30VAC to 150VAC.

PARAMETERS	RCF	Phase Angle	Acc. Class
30-150 V	50 ppm	2.0'	0.01%

1.10 About this Operations Manual

This manual provides complete information for setting up and operating the KVTS. This document instructs the user on the following operations of the KVTS:

- Setup and Installation
- Front Panel Features
- Graphical User Interface (GUI)
- Operating Procedures
- Instrument Maintenance

2.0 SETUP & INSTALLATION

2.0 SETUP & INSTALLATION 7

2.1 Introduction 8

2.2 AC Power 8

2.3 Interlock 8

2.4 Cables for Transformer Connections..... 9

2.5 Circuit Breaker (KVTS) 9

2.6 Circuit Breaker (KATC-V2)..... 9

2.1 Introduction

The Instrument is shipped in a container designed to prevent damage during shipping.

Inspect the Instruments carefully for damage, and immediately report any damage to the shipper. A packing list is included in the packaging. When you unpack the Instruments, check for all the standard equipment listed and check the shipping order for any additional items ordered. Report any shortage to the place of purchase, to your distributor, or directly to TESCO.

2.2 AC Power

The KVTS is shipped with the power cable attached and routed through the rear panel. For shipping purposes, the cable is then inserted through the cutout in the lower, rear panel of the KVTS console. Remove the cable from its shipping position. The end of the cable is terminated with a twist-lock type of connector. This type of connector is used to lessen the chance of the KVTS being inadvertently unplugged while a test is in progress.

Attached to the plug at the end of the power cable is the mating female twist-lock connector. This connector should be securely mounted to the wall prior to plugging in the KVTS.

NOTE: It is very important that the ground connection be attached to a solid earth ground.

If desired, the twist-lock may be removed from the power cable and the cable may be directly wired to 120-volt supply. If this is done, it is still important that the ground lead be connected to a solid earth ground.

2.3 Interlock

Remove the lower, front panel to gain access to the connection panel.

The interlock terminals on the connection panel are provided if the 2J4 (and/or 2J6) and the TUT will be in a separate cage for safety purposes. In this case, the interlock terminals should be wired to a switch on the cage door such that when the door is open, the switch is open. The open switch causes the KVTS to remove voltage from the transformers inside the cage. If this feature is used, remove the jumper from the INTERLOCK terminals.

NOTE: Knopp strongly recommends that the 2J4 (and/or 2J6) transformer be placed in a safety cage and that the interlock terminals be connected to a switch on the door of that cage. Failure to do so could expose the operator to lethal voltages.

2.4 Cables for Transformer Connections

These cables are connected to the terminal board, coiled up, and laying on the floor of the console. Access to these cables is provided by the cutout in the lower, rear panel of the KVTS.

Also included with the cables is the “HV jumper” (high voltage jumper) which is used to select the proper voltage range corresponding to the transformer-under-test.

2.5 Circuit Breaker (KVTS)

Check the circuit breaker located below the writing surface to ensure that it is in the ON position.

2.6 Circuit Breaker (KATC-V2)

This circuit breaker protects the internal circuitry of the KATC-V2 Comparator and is located on the rear panel of the Comparator. However, if it is tripped due to excessive errors, the KATC-V will still display results. These results will be erroneous. This breaker must be ON.

To gain access to this breaker, the rear panel of the KVTS console must be removed. It is secured by six (6) screws. The circuit breaker is shown below:

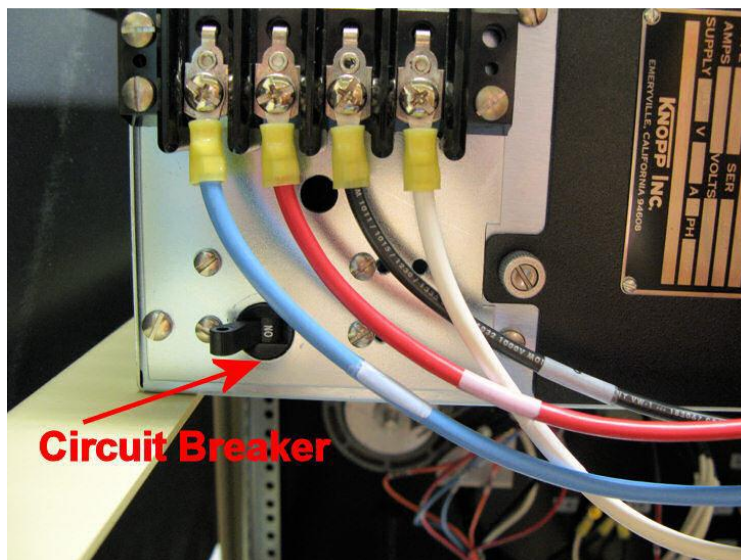

3.0 FUNCTIONALITY

- 3.0 FUNCTIONALITY 10
- 3.1 Introduction 11
- 3.2 Front Panel 11
 - 3.2.1 KVTS..... 11
 - 3.2.2 KATC-V2 12
- 3.3 Operating Procedure..... 13
 - 3.3.1 Setting Network Connection 14
 - 3.3.2 Testing Procedure 15

3.1 Introduction

This chapter is a reference for the functions and locations of the KVTS’s front panel features and provides brief descriptions of each feature for quick access. **Please read this information before operating the KVTS.**

3.2 Front Panel

3.2.1 KVTS



#	NAME	DESCRIPTION
1	POWER Switch	This switch is a combination switch/circuit breaker/indicator for the 120 VAC control circuitry. This switch makes available power to the control circuitry and comparator.
2	VOLTAGE ON (white)	This pushbutton applies power to the loading circuitry. The red lamp below this pushbutton is lit when the loading circuitry is energized. Note that both the fine and coarse variacs must be at zero before pressing this button or no voltage will be applied by the KVTS.
3	VOLTAGE OFF (red)	This pushbutton is used to de-energize the loading circuitry.
4	BURDEN Select Switch	This switch determines the ANSI burden to be inserted in the secondary of the transformer-under-test. The two terminals above this switch are to be used for an external burden.
5	VOLTAGE-FINE	Variac provides fine control of the voltage.
6	VOLTAGE-COARSE	Variac provides coarse control of the test voltage. The amber light (READ) located below the VOLTAGE ON pushbutton is on when both variacs are at zero—indicating that the loading circuitry can be energized (TEST VOLTAGE cannot be applied when either variac is off zero). The red light (ON) located next to the amber light indicates that the test Voltage is applied to the transformer test set and the transformer-under-test.

Table 3.2.1. KVTS Front Panel Sections

3.2.2 KATC-V2

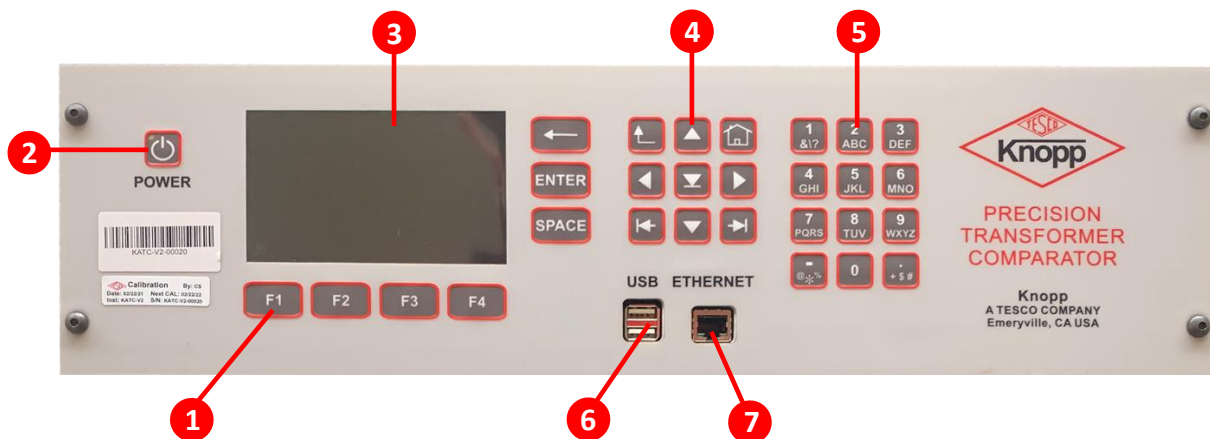















Figure 3.2.1. KATC-V2 Front Panel

NUMBER	DESCRIPTION
1	Function keys
2	Power button
3	TFT LCD Screen. 5" 800x480, full color TFT LCD screen
4	Navigation Keys
5	Alphanumeric membrane keyboard
6	Dual USB Connection
7	RJ45 Ethernet Connection

Table 3.2.1. KATC-V2 Front Panel

Navigation Keys

SYMBOL	DESCRIPTION
 or 	Functions any of the following: <ul style="list-style-type: none"> Selects the NEXT or PREVIOUS MENU item. Moves the SELECTED LINE UP or DOWN Select an Item from a dropdown menu
 or 	Functions any of the following: <ul style="list-style-type: none"> Moves the cursor left/right of the current character in text boxes. Moves the selection left/right of the current selected cell in tables.
 or 	Selects the NEXT or PREVIOUS TAB item.
	Deletes the previous character
	Returns to the previous screen
   	Function Keys
	Power button
	Selects a response

3.3 Operating Procedure

This section shows how to operate the KVTS with the KATC-V2 comparator. Before proceeding to the test, properly turn ON the equipment by doing the following:



1. Connect 120 V power cord at the back of the equipment.
2. Press KVTS power button to power it ON.
3. Press KATC-V2 power button to power it ON.

Connect the transformer-under-test to 2J4:

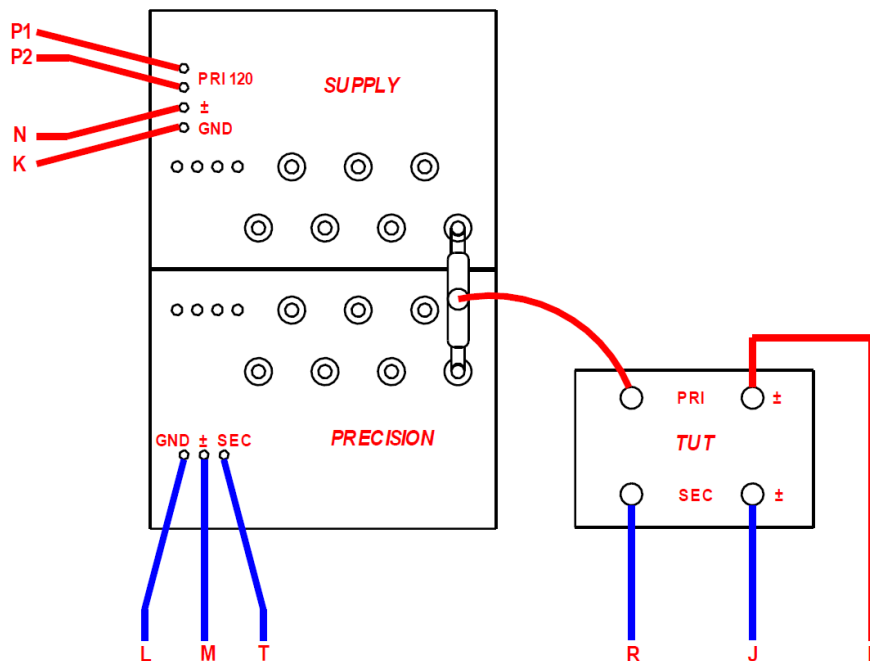
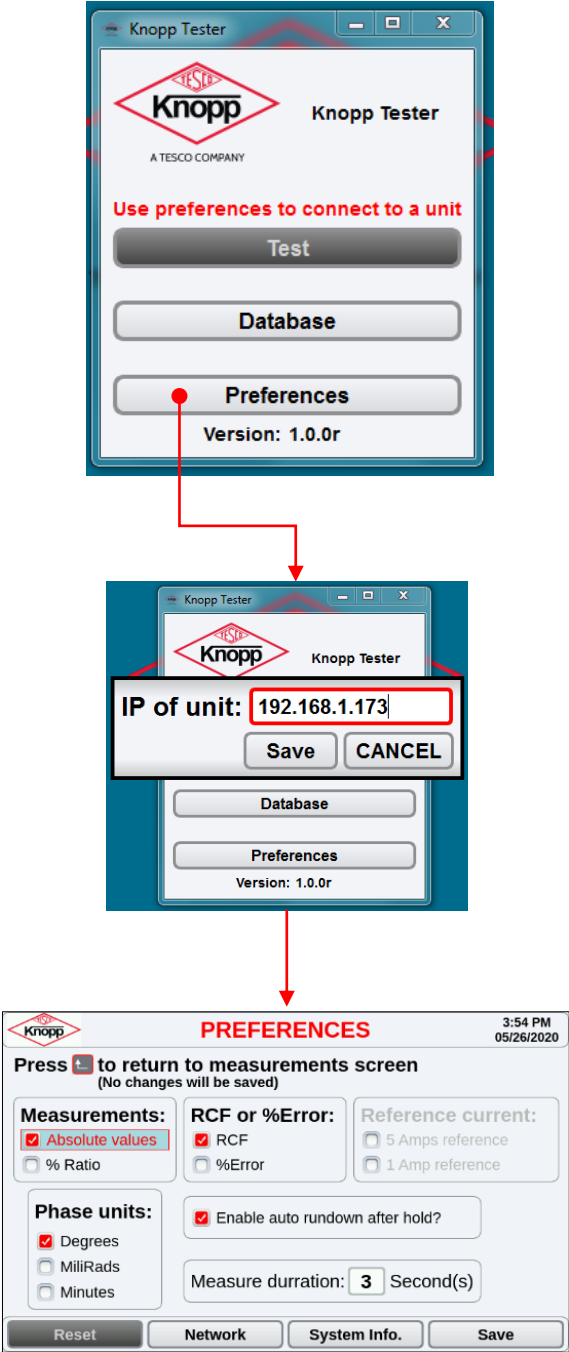

Figure 3.3 2J4-KVTS Connections

3.3.1 Setting Network Connection

SCREEN	DESCRIPTION
	<p>To use the remote connection for the comparator, do the following:</p> <ol style="list-style-type: none"> 1. Use a LAN cable to connect the PC/laptop to the equipment. The LAN port of the equipment is found on the comparator's front panel. For more info of the front panel, see section 3.2 Front Panel. 2. Make sure that the Knopp Tester application is already installed. The installer is included in the package of the equipment. 3. Open the Knopp Tester application. 4. Proceed to Preferences. 5. Change the IP address in the application and use the same IP address of the equipment which can be seen in the Preferences section of the equipment. 6. After entering the IP address, click SAVE. 7. Once the connection is established, proceed to Preferences to check your preferred settings for the test. <p>NOTE: Enabling auto rundown after hold is preferable to be selected all the time because every time the HOLD button is pressed, the big Variac inside exciting the loading transformer is going to rundown to zero. This is for safety reasons.</p>

3.3.2 Testing Procedure

The following procedure describes use of the KVTS with a KATC-V2 Comparator.

SCREEN	DESCRIPTION
	<ol style="list-style-type: none"> Using the HV jumper, select the appropriate range on the 2J4 (or 2J6) set. Select the desired burden on the BURDEN switch. Check to see that the amber READY lamp is lit. If not, turn the coarse and fine control variacs to zero. The loading circuitry cannot be energized until the amber lamp is lit (variacs at zero). Press and release the VOLTAGE ON pushbutton. Open the Knopp Tester App and proceed to Test. Enter the information about the comparator especially the required information (indicated by *) to continue with the testing. The TUT serial number can be found on its nameplate. Once all the required parameters are filled, press Continue. Make sure to select Auto Save to automatically save the test results into the database of the application. Adjust the COARSE and FINE control variacs for the desired secondary test voltage as indicated by the KACT-V2. <p>NOTE: Whenever voltage is present on the 2J4 (or 2J6) transformer set, all terminals on those transformers are energized.</p> <p>It is the operator's responsibility to be aware of, and follow, all company safety rules which deal with working in the presence of high voltages.</p>

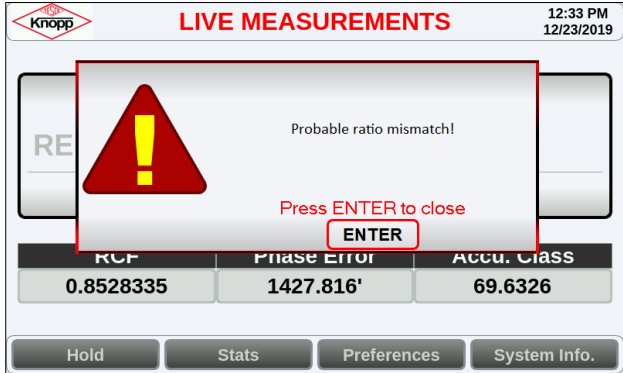
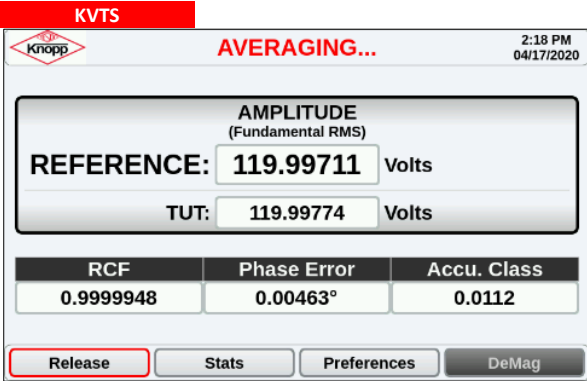
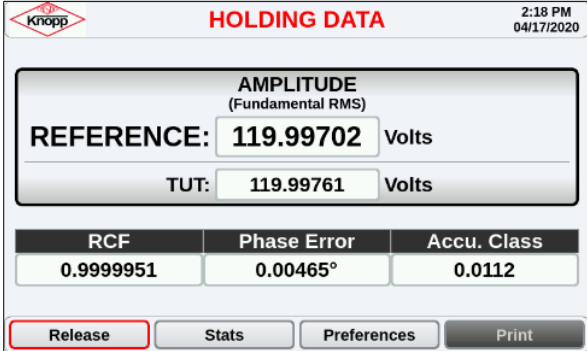
SCREEN	DESCRIPTION						
 <p>LIVE MEASUREMENTS 12:33 PM 12/23/2019</p> <p>Probable ratio mismatch! Press ENTER to close</p> <table border="1"> <thead> <tr> <th>RCF</th> <th>Phase Error</th> <th>Accu. Class</th> </tr> </thead> <tbody> <tr> <td>0.8528335</td> <td>1427.816°</td> <td>69.6326</td> </tr> </tbody> </table> <p>Hold Stats Preferences System Info.</p>	RCF	Phase Error	Accu. Class	0.8528335	1427.816°	69.6326	<p>NOTE: The KATC-V2 detects most connection errors and runs down the motorized variable transformer. However, current from the fine variable transformer must be manually returned to zero.</p>
RCF	Phase Error	Accu. Class					
0.8528335	1427.816°	69.6326					
<p>8</p>  <p>KVTS AVERAGING... 2:18 PM 04/17/2020</p> <p>AMPLITUDE (Fundamental RMS) REFERENCE: 119.99711 Volts TUT: 119.99774 Volts</p> <table border="1"> <thead> <tr> <th>RCF</th> <th>Phase Error</th> <th>Accu. Class</th> </tr> </thead> <tbody> <tr> <td>0.9999948</td> <td>0.00463°</td> <td>0.0112</td> </tr> </tbody> </table> <p>Release Stats Preferences DeMag</p>	RCF	Phase Error	Accu. Class	0.9999948	0.00463°	0.0112	<ol style="list-style-type: none"> After the readings stabilize, press HOLD on the comparator to initiate the measurement. If you check the Knopp Tester app, the record was saved after pressing HOLD. The measurements can be viewed in the database of the application, and these can be exported into a .csv file to the default directory: C:/TESCO/KnoppTester/export.csv. Return the variacs to zero. Press RESET on the KATC-V2 to prepare for the next measurements. Press VOLTAGE OFF after all measurements on a given transformer are complete.
RCF	Phase Error	Accu. Class					
0.9999948	0.00463°	0.0112					
 <p>HOLDING DATA 2:18 PM 04/17/2020</p> <p>AMPLITUDE (Fundamental RMS) REFERENCE: 119.99702 Volts TUT: 119.99761 Volts</p> <table border="1"> <thead> <tr> <th>RCF</th> <th>Phase Error</th> <th>Accu. Class</th> </tr> </thead> <tbody> <tr> <td>0.9999951</td> <td>0.00465°</td> <td>0.0112</td> </tr> </tbody> </table> <p>Release Stats Preferences Print</p>	RCF	Phase Error	Accu. Class	0.9999951	0.00465°	0.0112	<p>NOTE: If excessive error voltage exists during the measurement, such as would be caused by wrong polarity or wrong ratio, the KATC-V will automatically de-energize the loading circuitry and sound an alarm. If this occurs, return both variacs to zero, correct the condition, press RESET, and proceed.</p>
RCF	Phase Error	Accu. Class					
0.9999951	0.00465°	0.0112					

4.0 MAINTENANCE

4.0 MAINTENANCE	17
4.1 Introduction	18
4.2 Knopp One-to-One Test	18
4.3 Repair / Parts Replacement / Recalibration	19

4.1 Introduction

This chapter explains how to perform the routine user maintenance required to your KVTS in optimal operating condition. The precision transformer calibration can be periodically checked by the Knopp One-to-One method, whereby the ratio and phase angle performance can be quickly and accurately checked without the use of an external reference standard.

4.2 Knopp One-to-One Test

To check the overall performance of the equipment, the One-to-One test can be performed periodically. The results can then be compared to the data originally supplied with the equipment.

To make connections for the One-to-One Test:

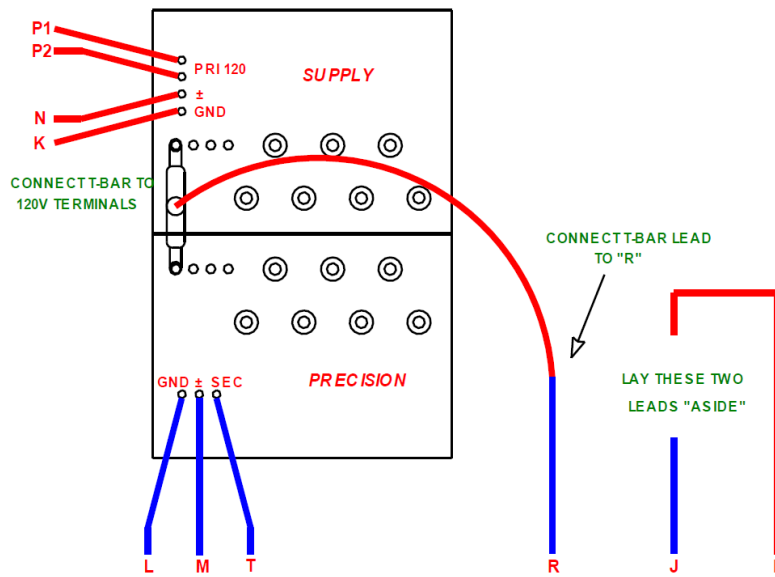

Figure 4.2 2J4 — KVTS Connections for One-to-One Test

1. Remove the transformer-under-test.
2. H and J are wired to ground and should be laid aside.
3. Connect HV jumper to 120 V terminals.
4. Join HV and R and isolate the junction from ground and other conducting points.

To perform the One-to-One Test:

The BURDEN switch should be in the EXTERNAL position. Refer to the One-to-One Data originally supplied with the transformer. Note the voltages at which the data were obtained (usually 105, 11, 120, and 130 volts).

1. Turn the KVTS and KATC-V2 power switches ON.
2. Check to see that the **amber** READY lamp is lit. If not, turn the coarse and fine control variacs to zero.
3. Press and release the VOLTAGE ON pushbutton.
4. Adjust the COARSE and FINE control variacs for the desired test voltage as indicated by the KATC-V2.
5. After the readings stabilize, press HOLD on the comparator to initiate the measurement. If you check the Knopp Tester app, the record was saved after pressing HOLD. The measurements can be viewed in the database of the application, and these can be exported into a .csv file to the default directory: C:/TESCO/KnoppTester/export.csv.
6. Return the variacs to zero.
7. Press RESET on the KATC-V2 to prepare for the next measurements.
8. Press VOLTAGE OFF after all measurements on a given transformer are complete.

The results should agree with the One-to-One data originally supplied with the equipment to within ± 1.0 minutes and $\pm 0.01\%$ on phase angle and ratio error, respectively.

NOTE: In this One-to-One test, the magnitudes of PHASE ANGLE and PERCENT RATIO ERROR displayed on the KATC-V2 are valid, but the signs are opposite. For example, if the ratio error is read as $\pm 0.2\%$, the actual error is -0.2% and the RCF would read 1.00200 but actually is 0.99800. If the phase angle reads $+4.5$ minutes ($+1.3$ milliradians), it is actually -4.5 minutes (-1.3 milliradians).

4.3 Repair / Parts Replacement / Recalibration

For the KVTS's repair, parts replacement, and recalibration, directly contact TESCO through phone or email. See section **1.2 Contacting TESCO** for contact details. TESCO recommends recalibration on an annual basis. Further details can be found on the Calibration Certificate provided with your KVTS.